

28 : Ignition system B200F/K, B200F

240, 1992, B200F, M47, YV1245273N1918729, 918729

16/7/2015





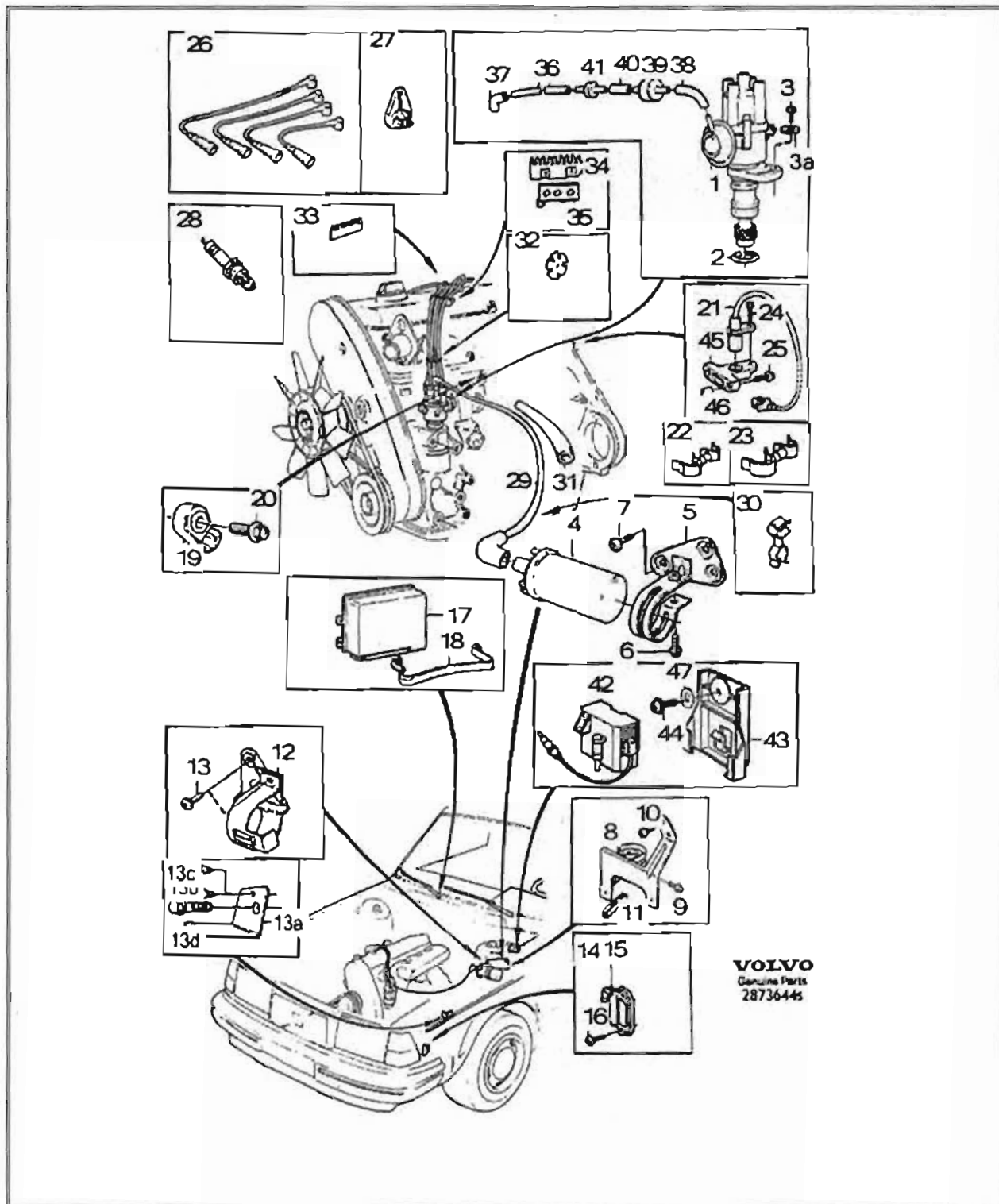









PRINT



**VOLVO**  
Genuine Parts  
28736445

Fig.	Description	Qty.	PS	Part number
1	Distributor	1.00		1367468
	Distributor 1367382			

	•	Distributor 1367468			
2		O-ring	1.00		949659
3		Hexagon screw (955296)	1.00		986985
3a		Washer (1336239)	1.00		986501
4		Ignition coll (1317810)	1.00		9438228
5		Clamp W/O P.S	1.00		1306056
6		Six point socket screw (956078)	1.00		986200
7		Six point socket screw	3.00		986122
8		Bracket P.S , W/O ABS	1.00		3517596
9		Six point socket screw (956078)	1.00		986200
10		Six point socket screw	3.00		986122
11		Edge protection moulding LG 87 mm	x		679754
12		Bracket P.S , INCL ABS	1.00		3540021
		Bracket 1993-	1.00		3540021
13		Six point socket screw	3.00		986122
14		Power unit, complete	1.00	NS	
15	•	Power unit	1.00		3501921
16	•	Six point socket screw	2.00		986116
17		Control unit	1.00		3531830
18		Brace	1.00		1389016
19		Sensor	1.00		1367644
20		Flange screw	1.00		985188
21		Impulse sensor	1.00		271949
22	•	Retainer	1.00		9146999
23	•	Retainer	1.00		3549774
24		Hexagon screw	1.00		986964
25		Flange screw	2.00		982759
26		Ignition cable kit, complete (271796)(271484)	1.00		272194
27		Retainer	2.00		1306510
28		Spark plug kit (270747)	1.00		272464
	•	Spark plug	4.00		1367529
		Spark plug kit	1.00		270746
29		Ignition cable, ignition coll- distributor W/O ABS	1.00		1306696
		Ignition cable, ignition coll- distributor INCL ABS	1.00		3547609
30		Retainer	1.00		3547026
		Ignition cable INCL ABS			
31		Protecting hose	x		1219815

R.H.D				
	32	Retainer	1.00	1266020
	33	Retainer	1.00	1276710
	34	Retainer	2.00	1266019
	35	Bracket	2.00	1357518
	42	Diagnostic unit	1.00	OP 1363923
	43	Bracket	1.00	1398776
	44	Six point socket screw REPL 1PCS 969278-1, , REPL 1PCS 986114, 1PCS 986498, , 1PCS 960138-6.	1.00	972079
		Six point socket screw	1.00	986114
	45	Bracket	1.00	3507510
	46	 Guide sleeve	2.00	463690
	47	Washer	1.00	986498

16/7/2015

PRINT



28 : Regulating system fuel supply B200F,B230F/FX/FD 240 4DRS CH 334100-, 240 5DRS CH 809000-, B200F, 5DRS W/O S.R

240, 1992, B200F, M47, L.H.D, YV1245273N1918729, 918729

28/7/2015



PRINT

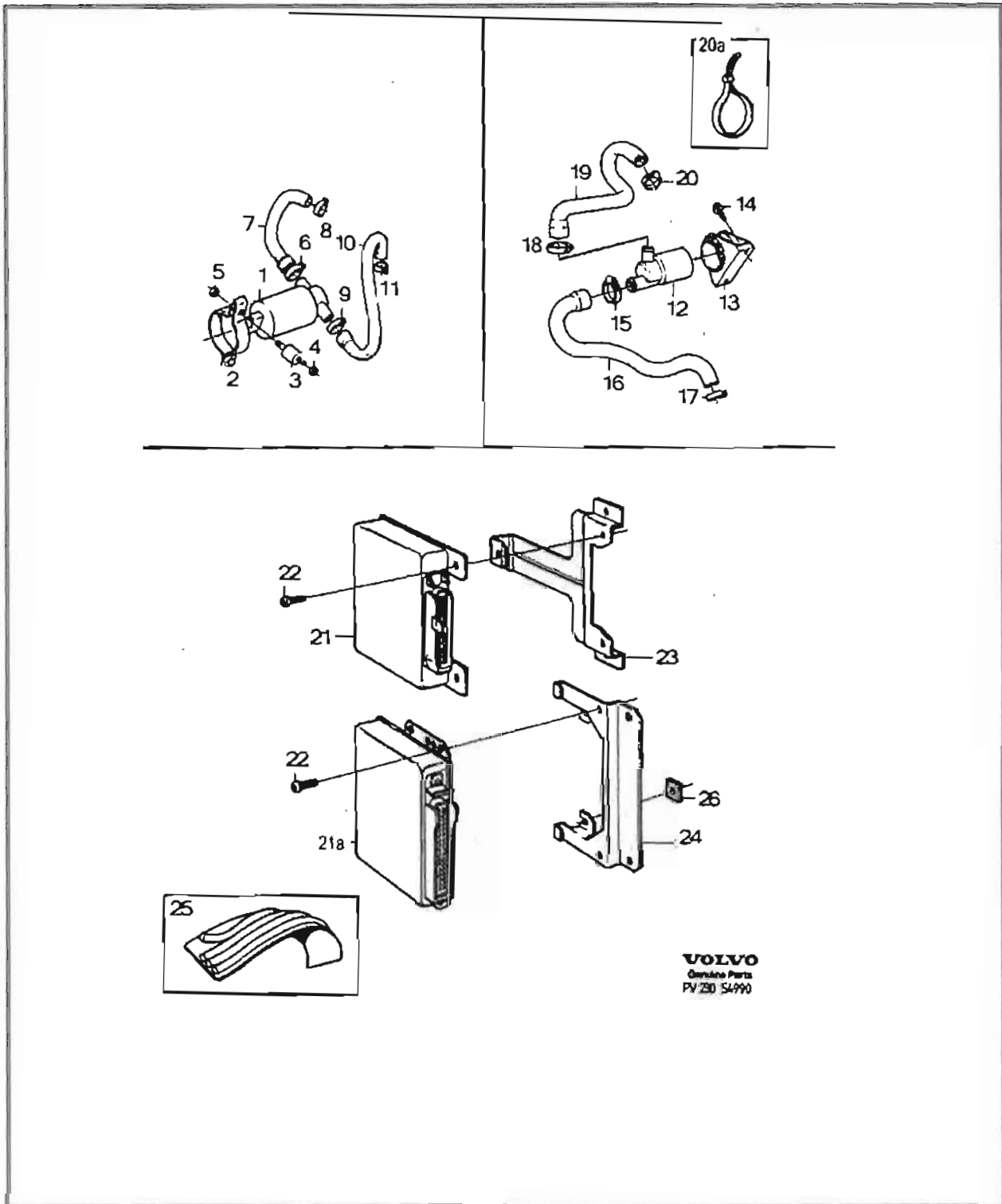

Fig.	Description	Qty.	PS	Part number
12	Control mechanism	1.00		1389618
13	Clamp	1.00		3501826
14	Flange screw	2.00		982759

15	Hose clamp	1.00		988025
16	Hose, inlet	1.00		3517084
17	Hose clamp -1991. (975279)	1.00		976584
	Hose clamp 1992-	1.00		988024
18	Hose clamp	1.00		988025
19	Hose, outlet	1.00		3517265
20	Hose clamp (975278)	1.00		976561
20a	Cable tie 1990-	1.00		948211
21a	Control unit, exch (3531206), B200F -1990	1.00	EU	5003771
	Control unit, exch B200F 1991-	1.00	EU	5003836
	Control unit, exch B230F	1.00	EU	5003926
	Control unit, exch B230FX 1993-	1.00	EU	5003926
	Control unit, exch B230FD 1993-, , (8601016)(5003945)	1.00	EU	8601150
22	Six point socket screw (949444)	2.00		986114
24	Bracket	1.00		3501183
25	Sealing strip	x	OP	591279
26	Plastic foam	2.00		1264112

28/7/2015

PRINT